

INTRINSIX

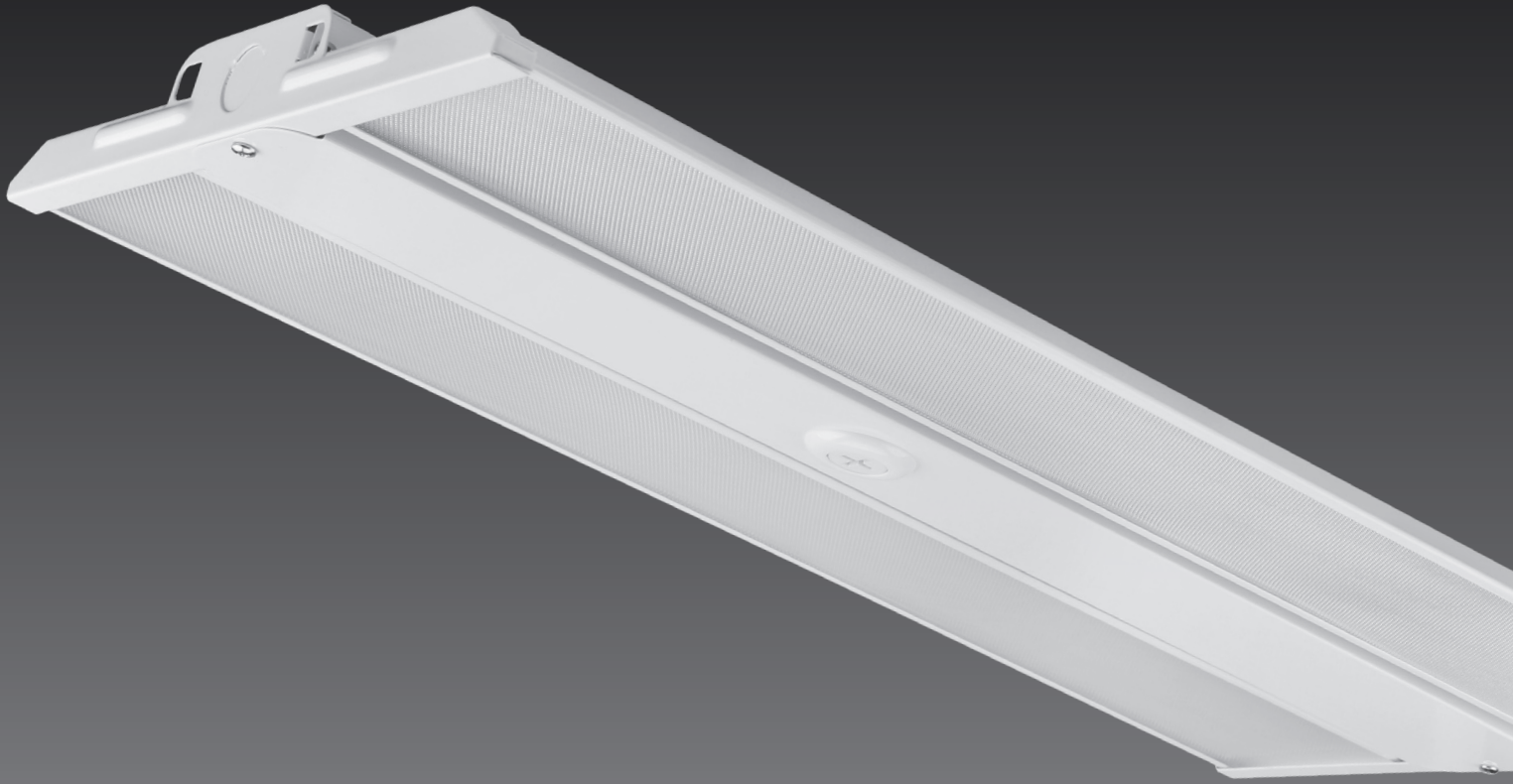

AURORA

PRODUCT PROFILE

AURORA

LINEAR LED HIGH BAY LIGHT

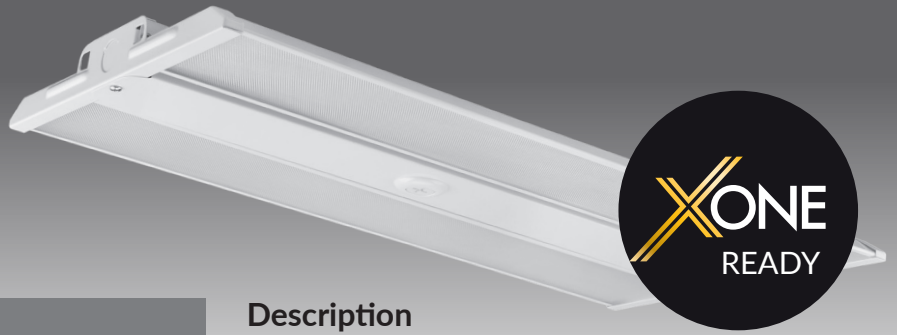

XONE READY AURORA.
FUTUREPROOFING LIGHTING TECHNOLOGY.



Description

IntrinsiX AURORA Led High Bay Lighting is capable of providing lighting to open spaces with high lumen output. These areas would include airport hangers, factories, warehouses and school gyms.

AURORA LED linear high bay produces a wide light distribution allowing for greater range. It also gives you the freedom to control the brightness with the optional Xone Advanced Lighting Control.

With a lifespan of over 50,000 working hours or 5 years, the AURORA LED lights are perfect for both new build and retrofit applications. These fixtures will have very little maintenance costs compared to the traditional high bay fixtures.

Specifications

- CCT: 4000/5000K
- Dimming: 0 to 10V
- Voltage: 120 to 277V, 50 to 60Hz
- Efficacy: 140Lm/W
- Operating Temp: -22°F to 122°F
- IP Rating: IP20
- Power Factor: >0.90
- DLC Listing: Premium
- Sensor: Z10 Sensor Base
- Warranty: 50,000 hours/5 years

Linear High Bay Fixture Details

Product Number	Watts (Selectable)	CCT(K) (Selectable)	CRI	Efficacy (Lm/W)	Lumen Output (Lm)	Operating Temperature	IP Rating	DLC Product ID
IX-LHBX-85S-40/50L0	65/75/85	4000 / 5000	>80	140	11,900/10,500/9,100	-22°F to 122°F	IP20	S-WY6INE
IX-LHBX-110S-40/50L0	70/90/110	4000 / 5000	>80	140	15,400/12,600/9,800	-22°F to 122°F	IP20	S-6LQ48E
IX-LHBX-130S-40/50L0	90/110/130	4000 / 5000	>80	140	18,200/15,400/12,600	-22°F to 122°F	IP20	S-EV6ASP
IX-LHBX-165S-40/50L0	130/150/165	4000 / 5000	>80	140	23,100/21,000/18,200	-22°F to 122°F	IP20	S-JSFZBX
IX-LHBX-220S-40/50L0	180/200/220	4000 / 5000	>80	140	30,800/28,000/25,200	-22°F to 122°F	IP20	S-YGRE1W
IX-LHBX-300S-40/50L0	255/275/300	4000 / 5000	>80	140	42,000/38,500/35,700	-22°F to 122°F	IP20	S-DJYV89
IX-LHBX-420S-40/50L0	320/380/420	4000 / 5000	>80	140	44,800/53,200/58,000	-22°F to 122°F	IP20	TBA



Distribution Diagram

IX-LHBX-85S-40/50LO

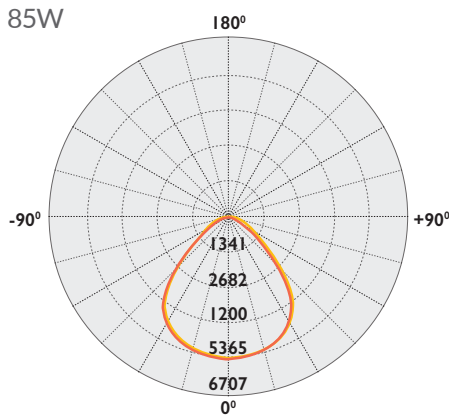

Average diffuser angle (50%) : 91.0°
 — C0-180
 — C90-C270

IX-LHBX-110S-40/50LO

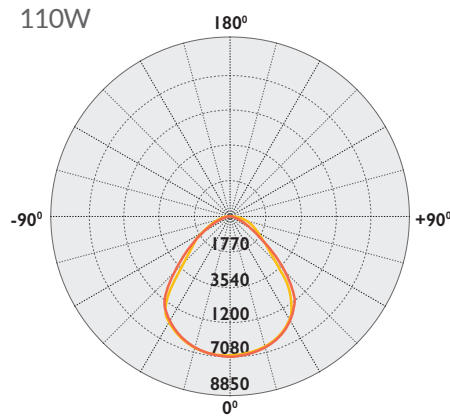

Average diffuser angle (50%) : 90.6°
 — C0-180
 — C90-C270

IX-LHBX-130S-40/50LO

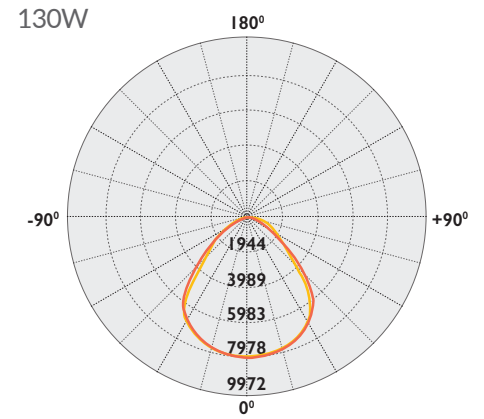

Average diffuser angle (50%) : 90.8°
 — C0-180
 — C90-C270

IX-LHBX-165S-40/50LO

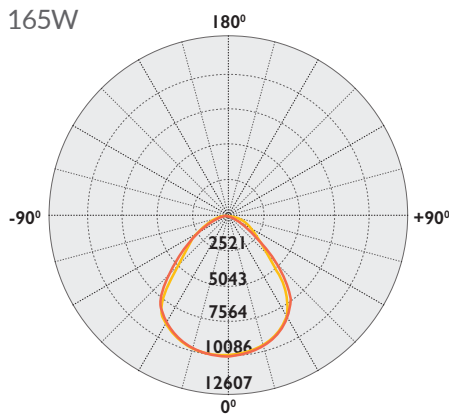

Average diffuser angle (50%) : 95.6°
 — C0-180
 — C90-C270

IX-LHBX-220S-40/50LO

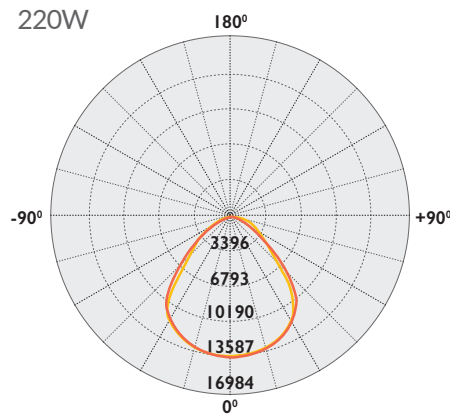

Average diffuser angle (50%) : 94.7°
 — C0-180
 — C90-C270

IX-LHBX-300S-40/50LO

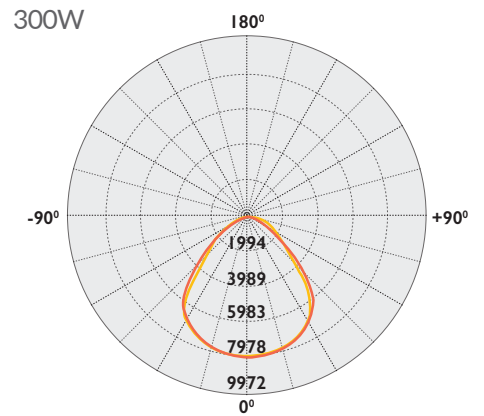

Average diffuser angle (50%) : 91.5°
 — C0-180
 — C90-C270

IX-LHBX-320W-50LO

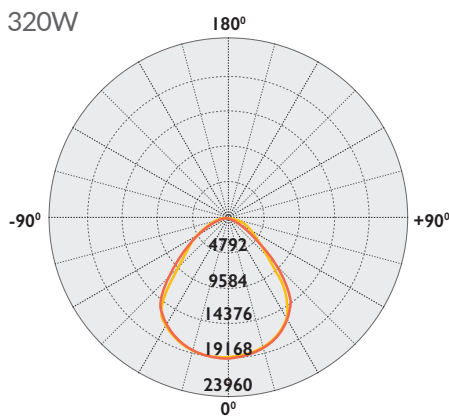

Average diffuser angle (50%) : 95.6°
 — C0-180
 — C90-C270

IX-LHBX-420W-40/50LO

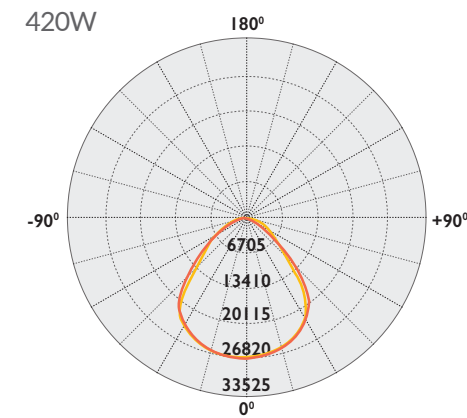

Average diffuser angle (50%) : 95.6°
 — C0-180
 — C90-C270

Product Dimensions

85W-300W

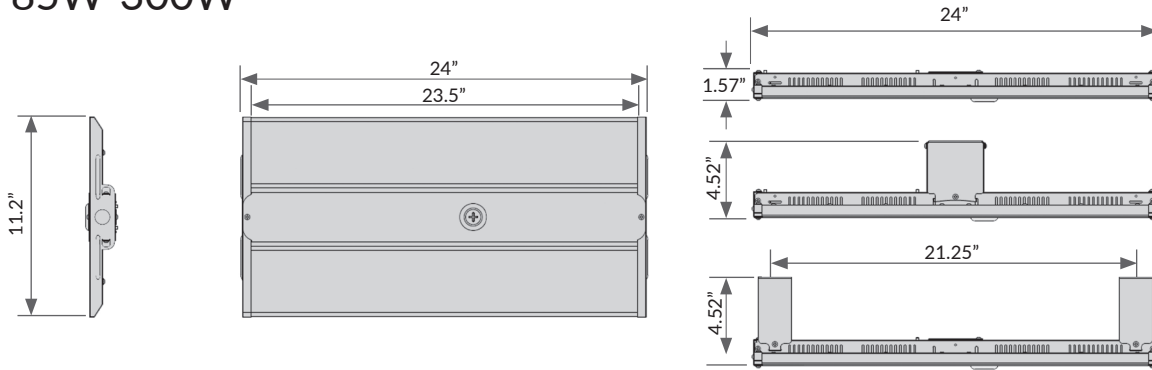

320W / 420W

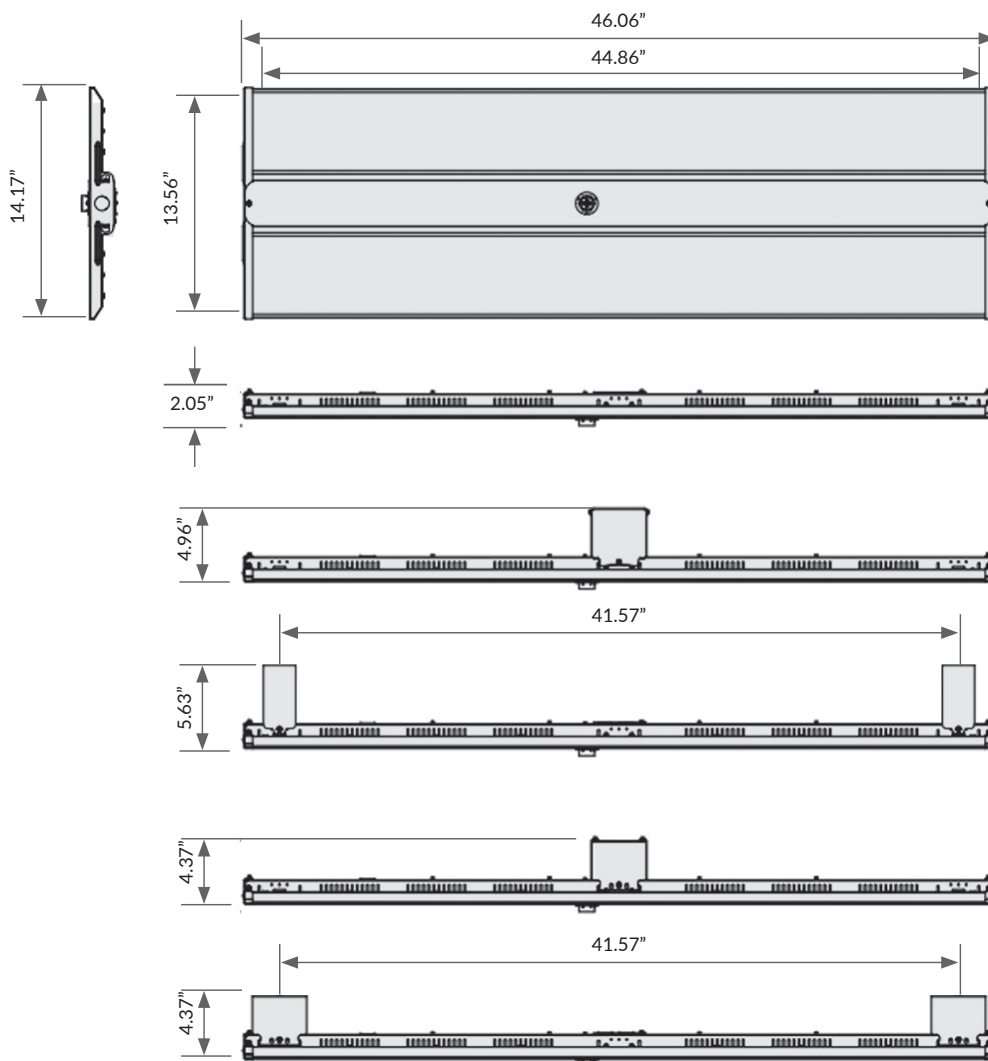

As the global safety science leader, UL helps companies to demonstrate safety, enhance sustainability, strengthen security, deliver quality, manage risk, and achieve regulatory compliance. The UL mark means that the global safety certification company UL has confirmed that the product has been independently tested and is safe for use.



The Federal Communications Commission (FCC) is an independent agency of the United States government that was created to regulate all forms of telecommunication inside of the U.S. including the radio frequency (RF) of electronics. Our products are fully tested ensure that they will not electromagnetically interfere with other products nor cause risk to the public as required by law.