

Project		Catalog #		Type	
Prepared by		Notes		Date	



Metalux

Cruze ST 22CZ2

2' x 2' LED Specification Grade Troffer

Typical Applications

Office • Education • Healthcare • Hospitality • Retail

Product Certification



Product Features



Interactive Menu

- Order Information page 2
- Photometric Data page 3
- Control Solutions page 5
- VividTune™ Color Tuning Solutions page 6
- BioUp - Melanopic Lighting page 7
- Product Warranty

Top Product Features

- Latch-less design provides clean architectural look
- BioUp melanopic lighting options for 30% circadian boost and earn WELL Building Standard points
- VividTune CCT tuning options from 3000K-5000K or 2700K-6500K
- Designers delight - ribbed, smooth and round perforated lens options
- High performance efficacy up to 151 lm/W
- Integrated sensor systems - occupancy, daylight and IoT connectivity
- Options to meet Buy American and other domestic preference requirements

Dimensional and Mounting Details

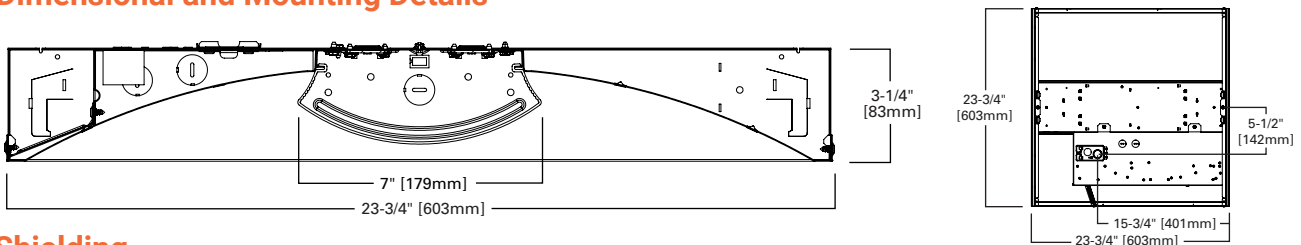

Shielding

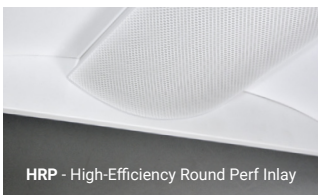

See ordering information for more shielding options.

Ceiling Compatibility

G	G	G	Ceiling Type	Trim Type
Grid/Lay-in Standard	Concealed T	Slot Grid	Exposed Grid	Standard
			Concealed T	Standard
			Slot Grid	Standard
			Flange	Standard
				*

*See Drywall Frame Kit Accessory in Ordering Information Section

Order Information

SAMPLE ORDER NUMBER: **22CZ2-34HE-UNV-L835-CD1-U**

Domestic Preferences ⁽¹⁾	Rating	Series	Air	Lumen Level / Efficacy Option			Shielding	Voltage ⁽⁵⁾	Options
[Blank] =Standard BAA =Buy American Act TAA =Trade Agreements Act	[Blank] =Standard ATW-SW4 =Chicago Rated	22CZ2-2x2 Cruze ST	[Blank] =Standard A =Air (Vented) ⁽²⁾	Standard [Blank] 20 =2000 Lumens ⁽⁴⁾ 24 =2400 Lumens ⁽⁴⁾ 32 =3200 Lumens ⁽³⁾ 39 =3900 Lumens ⁽³⁾ 44 =4400 Lumens ⁽³⁾	High Efficacy [HE] ^{(4),(5)} 20HE =2000 Lumens 24HE =2400 Lumens 29HE =2900 Lumens 34HE =3400 Lumens 39HE =3900 Lumens 44HE =4400 Lumens	Very High Efficacy [VHE] 20VHE =2000 Lumens 24VHE =2400 Lumens 29VHE =2900 Lumens 34VHE =3400 Lumens 39VHE =3900 Lumens 44VHE =4400 Lumens 50VHE =5000 Lumens 55VHE =5500 Lumens 60VHE =6000 Lumens ⁽⁵⁾ 65VHE =6500 Lumens ⁽⁵⁾ 70VHE =7000 Lumens ^{(3),(6)} 75VHE =7500 Lumens ^{(3),(6)} 80VHE =8000 Lumens ^{(3),(6)} 85VHE =8500 Lumens ^{(3),(6)} 90VHE =9000 Lumens ^{(3),(6)} 95VHE =9500 Lumens ^{(3),(6)} 100VHE =10000 Lumens ^{(3),(6)} 110VHE =11000 Lumens ^{(3),(6)}	[Blank] =Ribbed Frosted Acrylic Lens (standard) S =Smooth Frosted Acrylic Lens HRP =High-Efficiency Round Perf Inlay SQR =Square Ribbed Frosted Acrylic Lens	UNV =Universal Voltage 120-277 347V =347 Volt	GL =Single Element Fuse GM =Double Element Fuse PAF =Painted After Fabrication
Notes (1) Only product configurations with these designated prefixes are built to be compliant with the Buy American Act of 1933 (BAA) or Trade Agreements Act of 1979 (TAA), respectively. Please refer to DOMESTIC PREFERENCES website for more information. Components shipped separately may be separately analyzed under domestic preference requirements.			Notes (2) Air version is intended for air return through plenum. See air return data table for air flow volumes. Air option not available with ATW-SW4. Air requires "PAF" option.	Notes (3) VividTune white tuning and BioUp static and dynamic options are not available with these lumen/efficacy selections. (4) BioUp lumen option. (5) VividTune lumen option. (6) Available with CD and HCD drivers only.				Notes (5) Products also available in non-US voltages and frequencies for international markets.	

Emergency Options	CRI/CCT	Flex
[Blank] =No emergency EL7W =7-watt 120V-277V emergency battery pack ⁽⁶⁾ EL10W =10-watt 120V-277V emergency battery pack ⁽⁶⁾ EL14W =14-watt 120V-277V emergency battery pack ⁽⁶⁾ EL10WSD =10W emergency battery pack with self-diagnostic installed ^{(6),(8)} EL14WSD =14W emergency battery pack with self-diagnostic installed ^{(6),(8)} ETRD =Emergency Transfer Relay with dimming control ⁽⁷⁾ RRU =LVS Controls Emergency Transfer Relay with dimming control ⁽⁷⁾ UEL7W =UL924 Listed luminaire, 7-watt, 120V-277V emergency battery pack ^{(6),(10)} UEL14W =UL924 Listed luminaire, 14-watt 120V-277V emergency battery pack ^{(6),(10)} UEL10WSD =Bodine 10W emergency battery pack with self diagnostic installed ^{(6),(9),(10)} UETRD =UL924 Listed luminaire, Emergency Transfer Relay with dimming control ^{(7),(10)} URRU =UL924 Listed luminaire, LVS Controls Emergency Transfer Relay with dimming control ^{(7),(10)}	L830 =80CRI, 3000K L835 =80CRI, 3500K L840 =80CRI, 4000K L850 =80CRI, 5000K L930 =90CRI, 3000K L935 =90CRI, 3500K L940 =90CRI, 4000K L950 =90CRI, 5000K L83050 =80CRI 3000K-5000K White Tuning ⁽¹²⁾ L93050 =90CRI 3000K-5000K White Tuning ⁽¹²⁾ L82765 =80CRI 2700K-6500K White Tuning ⁽¹²⁾ L92765 =90CRI 2700K-6500K White Tuning ⁽¹²⁾ B35 =BioUp Static 3500K ⁽¹³⁾ B40 =BioUp Static 4000K ⁽¹³⁾ B50 =BioUp Static 5000K ⁽¹³⁾ B2750 =BioUp Tunable 2700K-5000K ⁽¹⁴⁾	[Blank] =No Flex A3/8-4/18GDIM =3/8" Flex with 0-10V Dimming Leads A3/8-2/18G =3/8" Flex with line and common A3/8-5/18GDIM =Flex with 0-10V Dimming leads and Blue for alternate wiring. See below for details.
Notes (6) Factory installed with integral test switch/indicator/laser test. For approximate delivered lumens multiply the lumens per watt of the desired fixture by the wattage of the emergency battery pack (100 lm/W x 7=700 lumens). IES-format photometry for luminaire under emergency operation available. Battery option increases total height by 1 inch. (7) Used to bypass local control during outage. Must be used in conjunction with UL 1008 device (provided by others). Devices are universal voltage (UNV), 347 not available. (8) EL10WSD and EL14WSD not available with 347V. (9) UEL10WSD not available with 347V. (10) Cannot be used with BioUp options.	Notes (12) VividTune provides correlated color temperatures (CCT) between 3000K (warm) to 5000K (cool) or 2700K (warm) to 6500K (cool). Must be used in conjunction with W2A driver only. Must be used with two (2) 10V dimming control channels, 1 cct, 1 intensity. May be combined with Wavelinx sensor control systems. (13) BioUp Static to be used with HCD driver. (14) BioUp Tunable provides correlated color temperatures (CCT) between 2700K (warm) to 5000K (cool). Must be used with W2A (for two channel 0-10V Control) or W2D (for 2 channel DALI Control) driver. See BioUp page for more information.	Flexible Metal Conduit Options Flex options available for 0-10V dimming control, DALI dimming control, emergency and night light functions. 72-inch factory-installed and pre-wired to driver, fitted to luminaire housing access plate with 90° enclosed FMC connector. Not all options may be combined and installation ratings vary by type. See online configurator for all flex options. A3/8-4/18GDIM series notes: Factory installed dimming option 3/8" flexible metal conduit with 2-#18 power and ground wires and 2-#18 UL-listed jacketed 0-10V +/- control wires. Meets UL 66, 83, 1479, 1569, 1581, 2556, NEC@ 250.118, 300.22(C), 392, 396, 330, 501, 502, 503, 530, 504, 505, 518, 520, 530, 645, 72; Federal Specification A-A-59544 (formerly J-C-30B); all applicable OSHA and HUD Requirements. UL Classified 1-, 2-, and 3-hour through penetration with applicable fire stop product (not included). May be surface mounted, fished and/or embedded in plaster. Cable tray and approved raceway rated, install per NEC®; Environmental Air-Handling Space Installation per NEC® 300.22(C).

Driver Type	No. of Drivers	Integrated Sensing Systems ⁽¹⁷⁾	Packaging	Accessories (order separately) ⁽²¹⁾
CD =0-10V Driver (10%-100% Dimming) ⁽²²⁾ HCD =0-10V Driver (1%-100% Dimming) ⁽²²⁾ 5LTD =DALI Driver (5%-100% Dimming) 5LTHD =DALI Driver (1%-100% Dimming) SD =Step Dimming Driver (50%-100% Dimming) LH =Lutron HiLume 1% EcoSystems (LDE1) ^(F) W2A =White Tuning, 2 ch, Analog 0-10V (1%-100% Dimming) ^{(15),(22)} W2D =White Tuning, DALI Type 8 (1%-100% Dimming) ⁽¹⁶⁾	1=1 Driver	[Blank] =No Sensor WLS (formerly WAB)=WaveLinx LITE Wireless Sensor, Occupancy w/ photocell, Independent & Networked ^{(19),(B)} WPS (formerly WAA)=WaveLinx PRO Wireless Sensor, Occupancy w/ photocell, Networked ^{(18),(A)} WLN =WaveLinx LITE Wireless Control Node, without sensor ^{(19),(B)} WPN =WaveLinx PRO Wireless Control Node, without sensor ^{(18),(A)}	U =Unit Pack PAL =Job Pack, out of carton PALC =Job Pack, in carton	CZ2-EQCLIP-U-PK ="CZ2" Earthquake Clip Kit (4 clips per bag kit) ⁽²⁰⁾ DF-22W-U =2' x 2' Drywall Frame Kit SK-22-WS =2' x 2' Shallow Surface Mount Kit SK-22-WT =2' x 2' Tall Surface Mount Kit
Notes (15) W2A used with two (2) 10V dimming control channels - CCT and intensity. (16) W2D for use with BioUp options only. White tuning CCT between 2700K and 5000K. Must be used with DALI controls; one address to control two channels - intensity and CCT. May not be used with sensing systems. For Emergency options ONLY EL10WSD can be used. (22) When selecting 0-10V driver with Integrated Sensing System a 0-10V driver might be substituted with another type. Integrated options must be used in conjunction with the associated system and may not be compatible with other options or accessories. Please refer to the following: (F) Consult Marketplace Options - Lutron system pages for additional details and compatibility. Compatible only with driver series shown, and may require two or more drivers. Requires field commissioning to operate or dim. Contact Lutron at www.lutron.com .		Notes (17) Matching width lens band on other side of sensor band may be supplied for symmetrical appearance. Required for use with sensor and emergency combination. Add "D" to sensor ordering as shown - WPSD, WLSd. (18) WPS sensor and WPN node to be used with CD, HCD or W2A driver. (19) WLS sensor and WLN node to be used with CD or HCD driver. Integrated options must be used in conjunction with the associated system and may not be compatible with other options or accessories. Please refer to the following: (A) Consult WaveLinx PRO system pages for additional details and compatibility. (B) Consult WaveLinx LITE system pages for additional details and compatibility.		Notes (20) An EQ Grid Clip is recommended for all 9/16" ceiling systems. Four required per fixture. (21) Accessories sold separately will be separately analyzed under domestic preference requirements. Consult factory for further information.

Product Specifications

Construction

- Die formed of code gauge prime cold rolled steel with full length die-formed stiffeners
- Unibody endplates attached with interlocking tabs and screws
- Hemmed side flanges
- Four auxiliary fixture end suspension points
- Integral Grid-lock feature for endplates for added safety
- Optional earthquake clips available

Integrated Controls

- Standard with 0-10V dimming driver (10% standard, 1% optional)
- Integrated WaveLinX options provide wireless individual fixture control and enable code compliance, increased energy savings, grouping of fixtures, and connection to WaveLinX control systems
- DALI 2.0, Lutron, and step-dimming available

LED and Light Engine

- LED's available in 3000K, 3500K, 4000K, or 5000K at 80 CRI minimum and 90 CRI minimum
- Color accuracy ≤ 3 -Step MacAdam ellipse (SDCM)
- TM21 life at 60,000 hours up to L90 and calculated L70 exceeds 203,000 hrs.
- Drivers available in 120-277V and 347V
- Tunable white options available with Cooper Lighting Solutions' VividTune
- BioUp melanopic lighting options available in static or tunable white

Emergency Battery Options

- 120V-277V integral emergency battery pack comes in 7-watts, 10-watt, or 14-watts
- Self-diagnostic emergency battery available in 10 or 14-watts (NFPA 101® Life Safety Code®)
- Constant power to the LED system for controlled, predictable discharge
- Integrated test switch/indicator light visible from floor
- Min. 90-minute backup period for code compliance
- Integral emergency transfer relay available for generator equipped power systems

Shielding

- Ribbed acrylic frosted lens standard
- Optional smooth acrylic frosted lens (S)
- Optional square ribbed frosted acrylic lens (SQR)
- Optional High-Efficiency Round Perf Inlay (HRP)
- Replacement lenses available, contact factory
- Lens is acrylic with features on the face and sides to optimize the direct and indirect lighting contributions for improved glare and efficacy

Compliance

- IC rated for insulation contact
- cULus listed for damp locations
- RoHS compliant
- Tested to IESNA LM-79 and LM-80
- Stated life tested to TM21 standards
- Can be used for State of California Title 24 high efficacy luminaire

Warranty

- Five-year limited warranty standard. Optional ten year limited warranty available.

Finish

- Multistage, iron phosphate pretreatment
- 90% reflective, matte white enamel finish
- Full fixture housing pre-painted matte white (choose PAF option for "Paint after Fabrication")

Photometric Data

[View IES files](#)

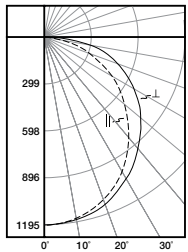

22CZ2-24-UNV-L830-CD1-U

Dimming Driver
 Linear LED 3000K
 Spacing criterion: (II) 1.2 x mounting height, (L) 1.28 x mounting height
 Lumens: 2437
 Input Watts: 21.9W
 Efficacy: 111.3 LPW
 Test Report: 22CZ2-24-UNVL830-CD1-U.IES

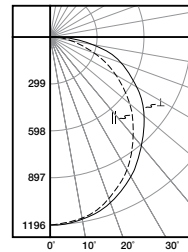

22CZ2-24HE-UNV-L830-CD1-U

Dimming Driver
 Linear LED 3000K
 Spacing criterion: (II) 1.19 x mounting height, (L) 1.27 x mounting height
 Lumens: 2402
 Input Watts: 19.2W
 Efficacy: 125.1 LPW
 Test Report: 14CZ2-29-UNV-L830-CD1-U.IES

Energy and Performance Data

Standard Efficacy Versions – Single Row of LEDs
Default CCT/Lumen Setting: 3500K/Med

Catalog Number	Lumens	Watts	lm/W
22CZ2-20-UNV-L835-CD1-U	2142	16.2	132
22CZ2-24-UNV-L835-CD1-U	2454	18.5	133
22CZ2-32-UNV-L835-CD1-U	3272	24.2	135
22CZ2-39-UNV-L835-CD1-U	3953	31	128
22CZ2-44-UNV-L835-CD1-U	4462	33	134

High Efficacy Versions – Two Rows of LEDs

Catalog Number	Lumens	Watts	lm/W
22CZ2-20HE-UNV-L835-CD1-U	2030	15.0	135
22CZ2-24HE-UNV-L835-CD1-U	2474	18.1	137
22CZ2-29HE-UNV-L835-CD1-U	2982	20.9	143
22CZ2-34HE-UNV-L835-CD1-U	3426	24.3	141
22CZ2-39HE-UNV-L835-CD1-U	3997	28.5	140
22CZ2-44HE-UNV-L835-CD1-U	4567	32.8	139

Very High Efficacy Versions – Three Rows of LEDs

Catalog Number	Lumens	Watts	lm/W
22CZ2-20VHE-UNV-L835-CD1-U	2008	14.2	141
22CZ2-24VHE-UNV-L835-CD1-U	2501	17.5	143
22CZ2-29VHE-UNV-L835-CD1-U	3114	21.7	144
22CZ2-34VHE-UNV-L835-CD1-U	3598	25.1	143
22CZ2-39VHE-UNV-L835-CD1-U	4078	28.6	143
22CZ2-44VHE-UNV-L835-CD1-U	4620	32.6	142
22CZ2-50VHE-UNV-L835-CD1-U	5095	36.2	141
22CZ2-55VHE-UNV-L835-CD1-U	5530	39.4	140
22CZ2-60VHE-UNV-L835-CD1-U	6110	44.1	139
22CZ2-65VHE-UNV-L835-CD1-U	6559	47.9	137
22CZ2-70VHE-UNV-L835-CD1-U	7017	50.3	140
22CZ2-75VHE-UNV-L835-CD1-U	7557	54.7	138
22CZ2-80VHE-UNV-L835-CD1-U	8092	59.1	137
22CZ2-85VHE-UNV-L835-CD1-U	8615	63.6	136
22CZ2-90VHE-UNV-L835-CD1-U	9125	68.2	134
22CZ2-95VHE-UNV-L835-CD1-U	9610	72.7	132
22CZ2-100VHE-UNV-L835-CD1-U	10108	77.7	130
22CZ2-110VHE-UNV-L835-CD1-U	11065	87.7	126

Shielding

Lumen Adjustment Factors		
S	HRP	SQR
1.05	0.80	0.96

Lumen Calculator

CCT Multiplier	80 CRI	90 CRI ⁽¹⁾	BioUp Static
3000K	0.965	0.827	-
3500K	1.000	0.847	0.912
4000K	1.019	0.856	0.899
5000K	1.019	0.909	0.879

Notes: (1) Input wattages for 90 CRI versions may vary. Refer to published IES-format photometry or LM-79 reports for more details.

Example of Lumen Adjustment Calculation

22CZ2-32-UNV-L935-CD1-U at 90CRI at 3500K

Lumen Adjustment Factor = 0.845

Total Light Output =

3,280 lm x 0.845 = 2,772 lm

Efficacy = 2,772 lm = 103.8 lm/W
26.7W

Lumen Maintenance

Version	TM-21 Lumen Maintenance (60,000 hours) ⁽²⁾	Theoretical L70 (Hours) ⁽³⁾
Standard	> 85%	> 151,000
High Efficiency	> 90%	> 203,000
Very High Efficiency	> 90%	> 203,000

Notes: (2) Supported by IES TM-21 standards. (3) Theoretical values represent estimations commonly used; however, refer to the IES position on LED Product Lifetime Prediction, IES PS-10-18, that explains proper use of IES TM-21 and LM-80.

Load Data (Stock Product)

Thd	6%
Power Factor	0.99
Weight (lbs.)	10.6
Low Temp. Start	-20°C

Shipping Data

Catalog No.	Wt.	Pallet 49"L x 52"W x 55"H
2' x 2'	12.5 lbs.	48

Air Return Volume

Negative Static Pressure (Inches H ₂ O)	Return Air Volume (CFM)
0.05	79
0.1	112
0.2	161
0.25	177
0.3	198
0.45	239

Control Solutions

- WaveLinX LITE wireless
- WaveLinX PRO wireless
- WaveLinX CAT wired
- WaveLinX Wired



The Cruze ST with WaveLinX offers no-hassle lighting control with multiple luminaire level control solutions.



WaveLinX PRO is a wireless lighting control solution, for connected spaces, that significantly reduces a building's energy consumption. From a single floor to an entire campus, WaveLinX PRO connects more than lighting assets; it shares aggregated sensor data with the WaveLinX CORE platform and other building systems, so building owners can improve operations, spaces environment, and tenants' experience. WaveLinX PRO offers a rich portfolio of wireless devices, WaveLinX PRO-enabled luminaires, and an intuitive WaveLinX mobile app for office, education, warehouse, and parking garage applications.



WaveLinX LITE is a cost effective, wireless digital lighting control solution, with out-of-the-box functionality, that saves energy and meets code. It's designed for applications that require occupancy-based, daylighting, or manual light control. Customize installations for office, education, warehouse and parking garages using the secure, simple mobile app.

Integrated Sensor Coverage Pattern

TOP VIEW:

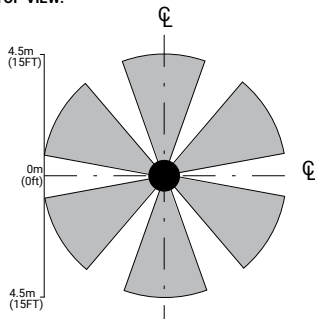

SIDE VIEW:

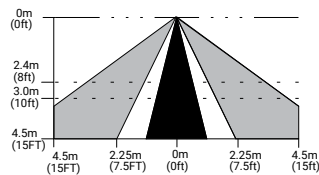

Note: Installation of integrated sensors within 3-ft (1m) of HVAC air vents is not recommended. The pattern shown is intended solely as a general guide and is not to scale.

With Integrated WaveLinX Sensor

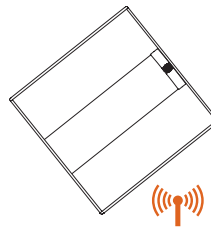

With Integrated WaveLinX Node

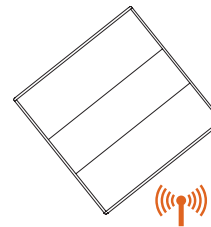

Add a hidden WaveLinX sensor node (WPN, WLN) to your space lighting design!

Allows to:

- Keeps luminaire aesthetics
- Connect fixtures without the realestate to include sensor option such as downlights
- Connect sealed fixtures without a standard sensor option such as products for clinical space.

Integrated Controls Options

Option	Out of the Box Functionality	Luminaire Level Lighting Control (LLC)	Automatic Dimming Photocell	Occupancy Sensing	CCT Control
WLS	X	X	X	X	
WLN		X			
WPS		X	X	X	X
WPN		X			X

Note: WaveLinX utilizes scenes to allow users to change an area's fixtures Correlated Color Temperature (CCT) and intensity using commissioned manual wireless wallstation scene control. To enable CCT adjustments through WaveLinX, include WPS or WPN devices in addition to VividTune or BioUp technologies for integrated fixture control.

Systems comparison chart

Cooper Lighting Solutions provides many lighting system solutions designed to satisfy code requirements and meet the unique needs of any project.



Luminaire with standalone sensor

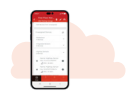

Standalone Spaces WaveLinX LITE



Standalone Spaces WaveLinX CAT



Networked Spaces WaveLinX PRO



Enterprise WaveLinX CORE

	Luminaire with standalone sensor	Standalone Spaces WaveLinX LITE	Standalone Spaces WaveLinX CAT	Networked Spaces WaveLinX PRO	Enterprise WaveLinX CORE
Occupancy	Yes	Yes	Yes	Yes	Yes
Daylighting	Yes	Yes	Yes	Yes	Yes
Wallstations	-	Yes	Yes	Yes	Yes
Gateways	-	-	-	1 WAC	300 WACs
Devices (MAX)	-	40 per Area (1120 per space)	40 per Area	200 per WAC2	32,500 per CORE Enterprise
Software	-	WaveLinX LITE Mobile App	WaveLinX CAT Mobile App	WaveLinX Mobile App	CORE
Areas	-	28 per Space	Unlimited	50 per WAC2	up to 3,000
Zones	-	16 per Area	16 per Area	16 per Area	up to 9,000
Scheduling	-	-	-	Local	Global
VividTune™	-	-	-	Yes	Yes
Plug-Load Control	-	Yes	Yes	Yes	Yes
Low-Voltage Power	-	-	Yes	Yes	Yes
Integration	-	-	-	-	BACnet, API
Dashboards	-	-	-	-	Energy, Occupancy
Configuration	-	Installer	Installer	Technician	Technician / IT



22 Cruze ST LED with VividTune Tunable White

VividTune tunable white luminaires from Cooper Lighting Solutions deliver high-quality light in a broad range of continuously variable color temperatures and intensities. Create a dynamic environment by adjusting the ambient light warmer or cooler to influence mood, support the task at hand, or create a dramatic ambience. The ability to control correlated color temperature and intensity separately using simple controls is the next evolution of LED lighting for the commercial, educational, healthcare and hospitality space. The unparalleled flexibility and number of available lighting environments enable users to find the right light with tunable white.

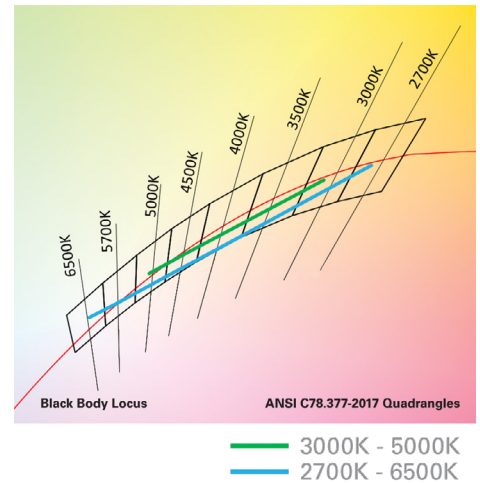

Energy and Performance Data

Tunable White - Lumen Adjustment Factors						
CCT	VividTune 3000K-5000K		VividTune 2700K-6500K		BioUp Tunable White 2700K-5000K	
	80 CRI	90 CRI	80 CRI	90 CRI	CRI	Lumen Adjustment
2700K	-	-	0.903	0.771	95	0.938
3000K	0.929	0.765	0.928	0.801	94	0.929
3500K	0.983	0.836	0.961	0.842	90	0.912
4000K	1.033	0.903	0.981	0.868	87	0.899
4500K	1.042	0.918	0.999	0.891	85	0.890
5000K	1.042	0.918	1.013	0.909	84	0.879
6500K	-	-	1.028	0.933	-	-

2' x 2' Cruze ST LED - Example of Approximate Lumen Calculation				
	Standard Catalog #	VividTune 80 CRI Catalog #	VividTune 90 CRI Catalog #	BioUp Tunable White
CCT Setting	22CZ2-34HE-UNV-L835-CD1-U	22CZ2-34HE-UNV-L83050-W2A1-U	22CZ2-34HE-UNV-L93050-W2A1-U	22CZ2-34HE-UNV-B2750-W2A1-U
2700K	-	3058	2611	3176
3000K	-	3026	2491	3146
3500K	3386	3202	2722	3088
4000K	-	3362	2940	3044
4500K	-	3394	2991	3014
5000K	-	3394	2991	2976
6500K	-	3481	3159	-

Controlling VividTune and BioUp Tunable White

From wall dimmers to wireless controls, tunable white luminaires are compatible with industry standard 0-10V and DALI controls. One channel to control intensity (brightness) and a second channel to adjust CCT.

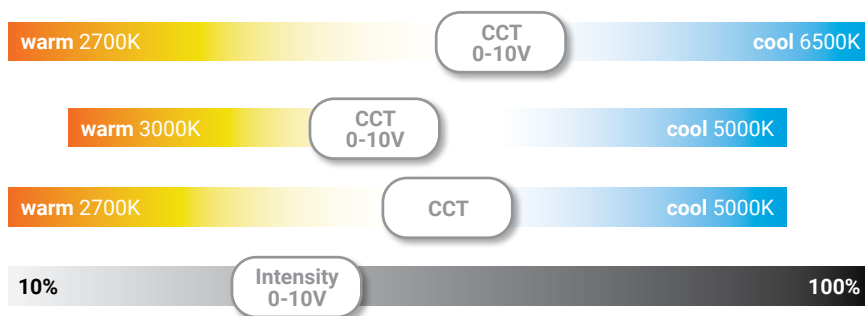

Example of Lumen Adjustment Calculation

22CZ2-34HE-UNV-L83050-W2A1-U at 80 CRI tuned to 3500K

Adjusted Lumen = published lm x adjusted lm factor

Adjusted Lumen = 3386 x 0.946

Adjusted Lumen = 3202 lm

* Lumen adjustment factors are for reference and may be different for each product selected. Refer to IES files for actual performance data on each.

Proven Research. Industry Recognized.

BioUp Melanopic Lighting



See better



Feel better



Function better



See [BioUp brochure](#) for more details

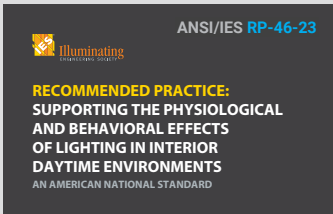

ANSI/IES RP-46-23 / TM18 published March 2024 based on over 40 years of research.

"...circadian clock synchronization is paramount to the body's efficient and appropriate functioning." – TM18



BioUp solutions maximize WELL points for Circadian Lighting Design (L03):

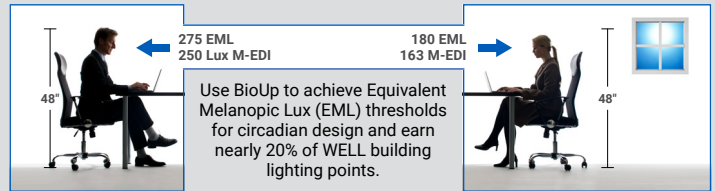

MDER, M-EDI and EML are key metrics used to quantify non-visual performance of indoor lighting systems.

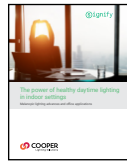

See [BioUp white paper](#) for more details

MDER - Melanopic Daylight Efficacy Ratio (MDER) measures the amount of light stimulating to the melanopsin receptors.

Standard 4000K LED
MDER = .62

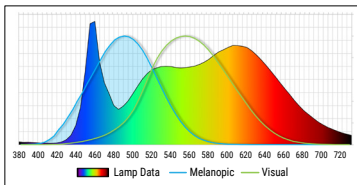

BioUp 4000K LED
MDER = .82

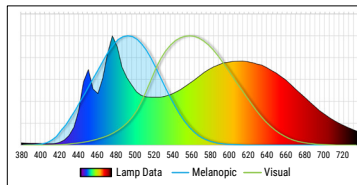

30% boost Biological impact compared to traditional LED sources

CCT	LED MDER ~83 CRI	BioUp Static		BioUp Dynamic	
		MDER	CRI	MDER	CRI
2700K	0.44	–	–	0.43	95
3000K	0.49	–	–	0.54	94
3500K	0.56	0.71	90	0.71	90
4000K	0.64	0.84	87	0.82	87
5000K	0.77	0.98	84	0.98	84

BioUp enhances the LED spectrum with cyan light at 475nm increasing the biological impact of the light to enhance our circadian rhythm which regulates our sleep/wake cycle, daytime engagement, and mood – **all without distorting visual color impression.**

Static (non-tunable)

Static BioUp is used when simple Melanopic Lighting is desired at all times.

Arrow in graph shows BioUp spectrum boost is at 475nm where non-visual biological response is enhanced.

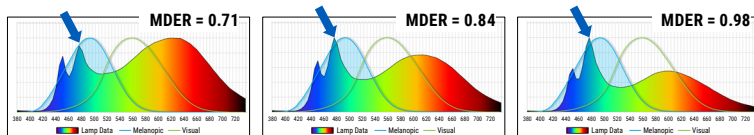

3500K or **4000K** or **5000K**

Cyan light component always present



> no CCT control needed

Dynamic - (Tunable)

Dynamic BioUp is used when Melanopic Lighting is desired to adjust during the day.

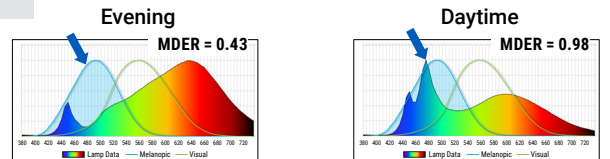

Warmer CCT Without Cyan content ← → Cooler Light With Cyan content

2700K – 5000K



> Control with Wavelinx, 2ch 0-10V, or DALI