

INTRINSIX

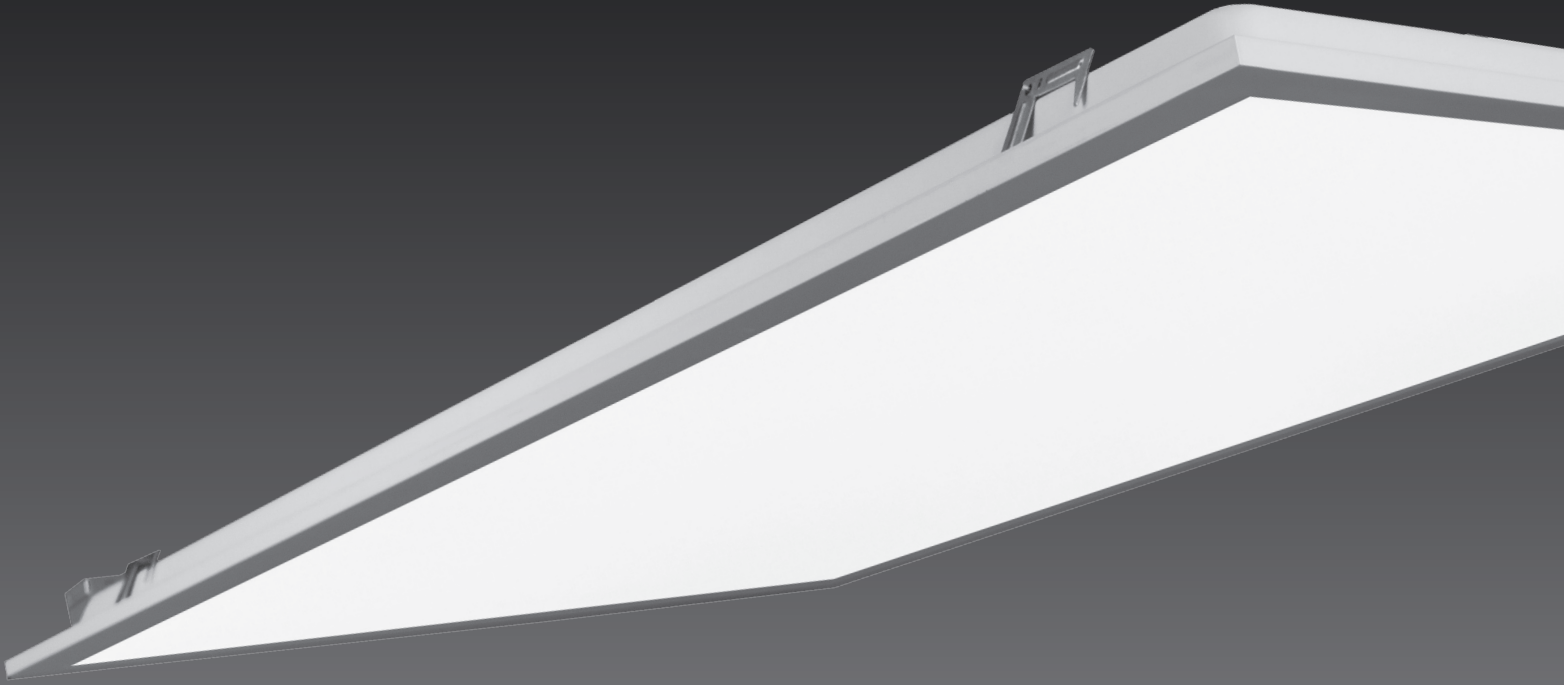

VISTA

PRODUCT PROFILE

# VISTA

## VISTA SERIES LED LIGHT PANEL



### Description

With the Intrinsic VISTA Series you can depend on an energy efficient design, an ultra-slim backlit panel light fixture which is perfect for renovations or new construction projects that require code compliant energy saving flat panel led solutions.

It also has a smart, smooth, and equal light distribution that ensures a wonderfully illuminated room.

Our VISTA Series LED back lit Light Panel is a flat LED panel ceiling light designed for commercial and industrial applications that require long-lasting efficient lighting such as retail, healthcare, hospitality and office environments.

### Specifications

- CCT: 3500/4000/5000K
- Dimming: 0-10V
- Voltage: 120 to 277V, 50 to 60Hz
- Efficacy: 140Lm/W
- Operating Temp: -4°F to 104°F
- IP Rating: IP20
- Power factor: >0.95
- DLC Listing: Premium
- Warranty: 50,000 hours/5 Years

### LED Light Panel Fixture Details

Product Number	Size	Watts (Selectable)	CCT(K) (Selectable)	CRI	Efficacy (Lm/W)	Lumen Output Temperature (Lm)	Operating Temperature	IP Rating	DLC Product ID
IX-FPBL-14-20/30/40-CCT	1' x 4'	20/30/40	3500/4000/5000	80+	140	2800/4200/5600	-4°F to 104°F	IP20	S-0M89ET
IX-FPBL-22-20/30/40-CCT	2' x 2'	20/30/40	3500/4000/5000	80+	140	2800/4200/5600	-4°F to 104°F	IP20	S-5WQRKE
IX-FPBL-24-30/40/50-CCT	2' x 4'	30/40/50	3500/4000/5000	80+	140	4200/5600/7000	-4°F to 104°F	IP20	S-ORDALS
IX-FPBL-24-30-40LO	2' x 4'	30	4000	80+	140	5600	-4°F to 104°F	IP20	S-6UINLP

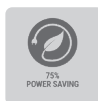

# Distribution Diagram

## IX-FPBL-14

20W

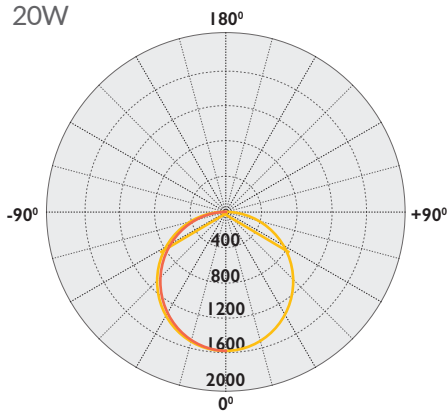

Average diffuser angle (50%) : 114.2°

- C0-180, 113.8
- C90-C270, 114.6

30W

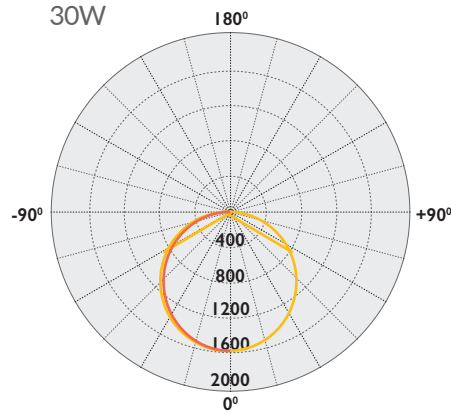

Average diffuser angle (50%) : 114.2°

- C0-180, 113.8
- C90-C270, 114.6

40W

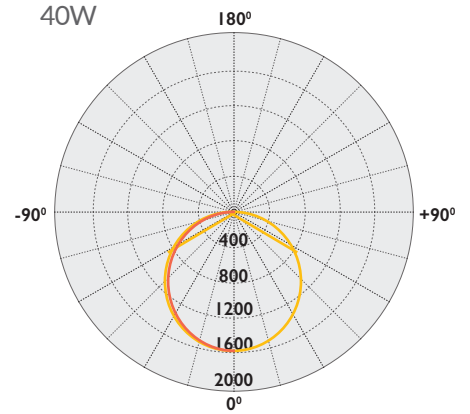

Average diffuser angle (50%) : 114.2°

- C0-180, 113.8
- C90-C270, 114.6

## IX-FPBL-22

20W

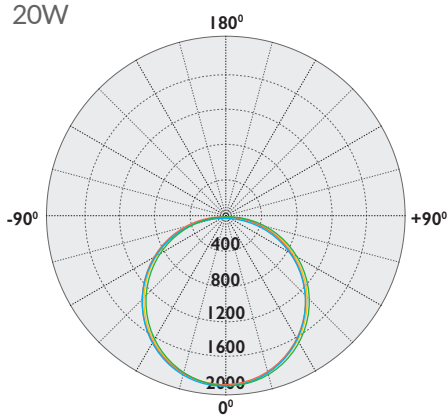

Average diffuser angle (50%) : 114.5°

- C0-180, 113.6
- C30-210, 113.3
- C60-240, 115.2
- C90-C270, 115.9

30W

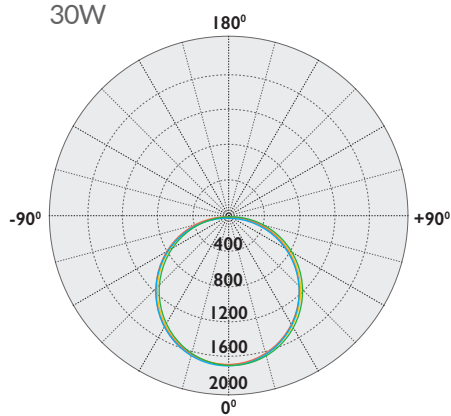

Average diffuser angle (50%) : 114.5°

- C0-180, 113.6
- C30-210, 113.3
- C60-240, 115.1
- C90-C270, 115.9

40W

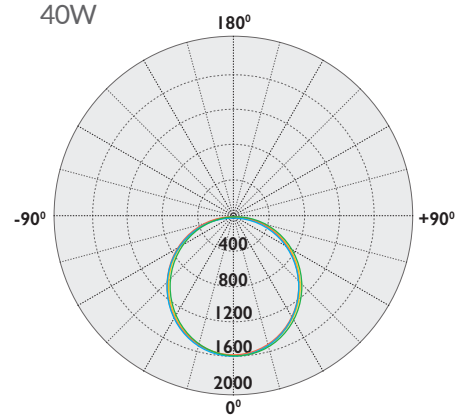

Average diffuser angle (50%) : 114°

- C0-180, 113.7
- C30-210, 113.4
- C60-240, 114.9
- C90-C270, 115.5

## IX-FPBL-24

30W

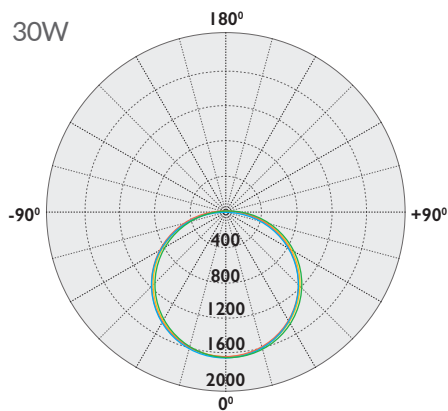

Average diffuser angle (50%) : 114.5°

- C0-180, 113.6
- C30-210, 113.3
- C60-240, 115.1
- C90-C270, 115.9

40W

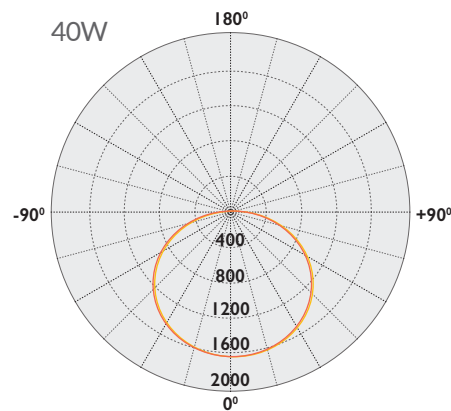

Average diffuser angle (50%) : 118.4°

- C0-180, 115.7
- C90-C270, 121.2

50W

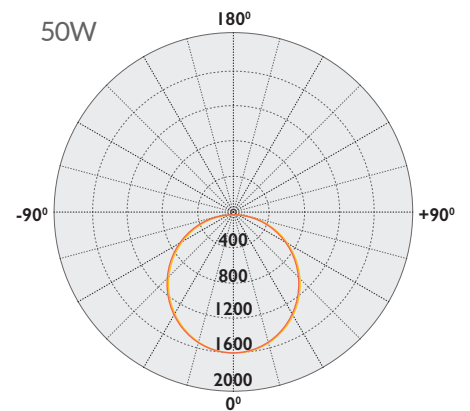

Average diffuser angle (50%) : 118.47°

- C0-180, 116.0
- C90-C270, 121.4

# Product Dimensions

Front view

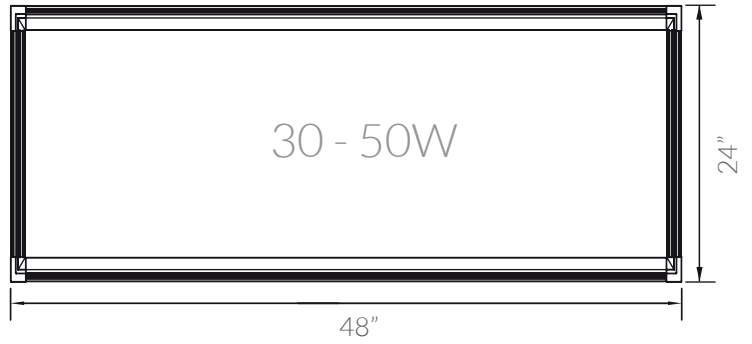
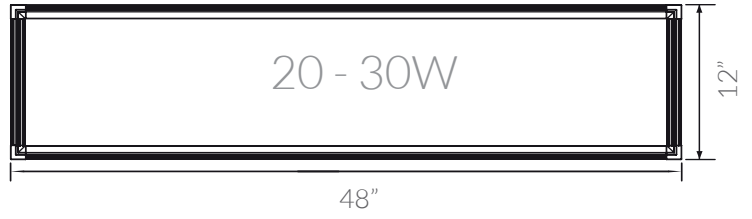
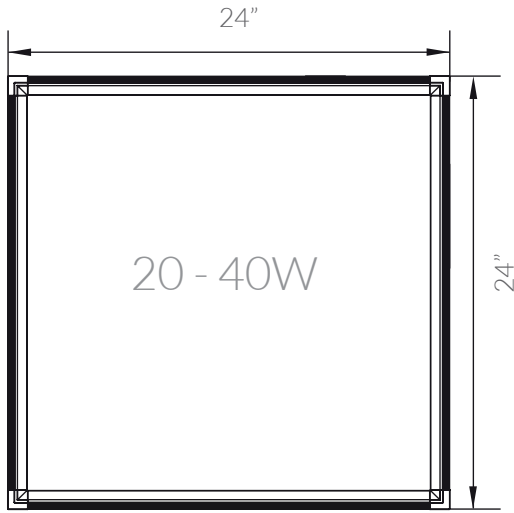

Intertek

The ETL Listed mark is an indicator of the product's compliance with safety regulations, recognized and accepted by the UL and CSA marks. As Intertek's ETL subjects' products to UL standards for safety, products marked as ETL Listed meet the same rigorous criteria as marked with UL Lister or UL Recognized. Intertek ETL is a Nationally Recognized Testing Laboratory (NRTL) recognized by the Occupational Safety and Health Administration (OSHA).



The Federal Communications Commission (FCC) is an independent agency of the United States government that was created to regulate all forms of telecommunication inside of the U.S. including the radio frequency (RF) of electronics. Our products are fully tested ensure that they will not electromagnetically interfere with other products nor cause risk to the public as required by law.